



TOP ELECTRONIC INDUSTRY CO., LTD.

www.topecind.com

GPS+GSM Combination Antenna

TOP-GSM/GPS04



DIMENSIONS

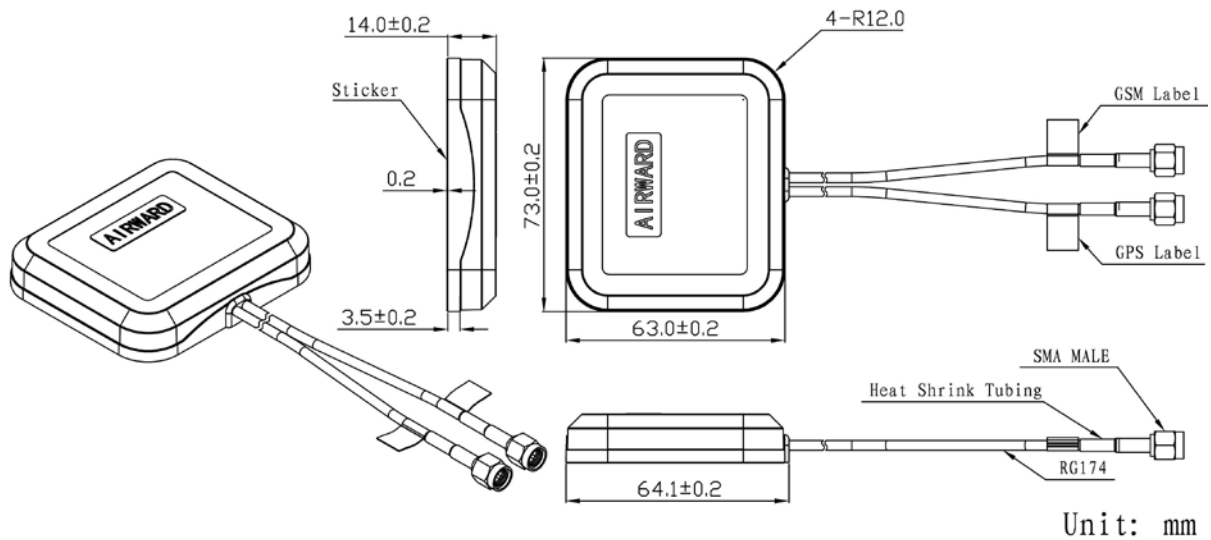

TOP ELECTRONIC INDUSTRY CO.,LTD

Rm407 27th Bldg,Nanhua Zone,Huaqiangan,Futian Dist,SZ,GD,China

Tel:+86-755-8281 5110

Fax:+86-755-8281 5220

Web: www.topecind.com



TOP ELECTRONIC INDUSTRY CO., LTD.

www.topelecind.com

SPECIFICATIONS

Item		Specifications	
GPS Antenna	Dielectric Antenna	Center Frequency	1575.42±1MHz
		Band Width	CF±5MHz
		Polarization	RHCP
		Gain	5dBic (Zenith)
		V.S.W.R	<1.5
		Impedance	50Ω
		Axial Ratio	3dB (max)
	LNA	Gain	28±2dB
		Noise Figure	<1.5
		Ex-band Attenuation	12dB@CF+50MHz/16dB@CF-50MHz
		V.S.W.R	<2.0
		Supply Voltage	2.2~5V DC
		Current Consumption	5~15mA
GSM Antenna		Frequency Range	824~960MHz/1710~2170MHz
		V.S.W.R (min)	<2.0
		Polarization	Linear
		Gain	2dBi
		Impedance	50Ω
Mechanical		Cable	RG174
		Connector	SMA/MCX/FAKRA or others
		Radome Material	ABS
		Mounting Method	Magnet/Adhesive
Environmental		Operating Temperature	-40°C~+85°C
		Relative Humidity	Up to 95%
		Ingress Protection	IP67
		Vibration	10 to 55Hz with 1.5mm amplitude 2hours
		Environmentally Friendly	ROHS Compliant

TOP ELECTRONIC INDUSTRY CO.,LTD

Rm407 27th Bldg,Nanhua Zone,Huaqiangnan,Futian Dist,SZ,GD,China

Tel:+86-755-8281 5110

Fax:+86-755-8281 5220

Web: www.topelecind.com



TOP ELECTRONIC INDUSTRY CO., LTD.

www.topelecind.com

Radiation Pattern

GPS Antenna

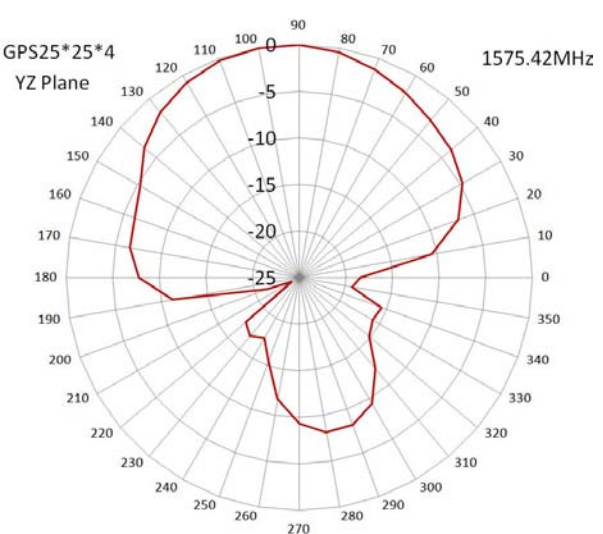
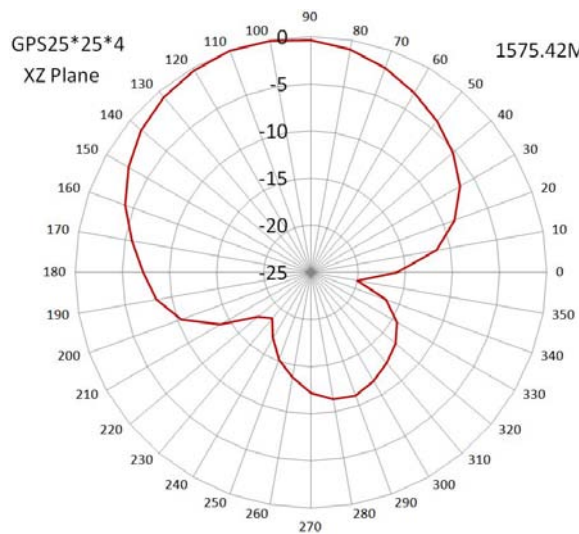
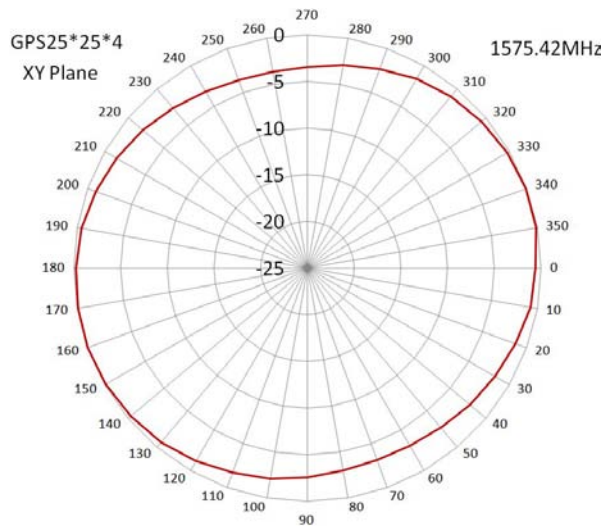

GSM Antenna

TOP ELECTRONIC INDUSTRY CO.,LTD

Rm407 27th Bldg,Nanhua Zone,Huaqiangnan,Futian Dist,SZ,GD,China

Tel:+86-755-8281 5110

Fax:+86-755-8281 5220

Web: www.topelecind.com



TOP ELECTRONIC INDUSTRY CO., LTD.

www.topelecind.com

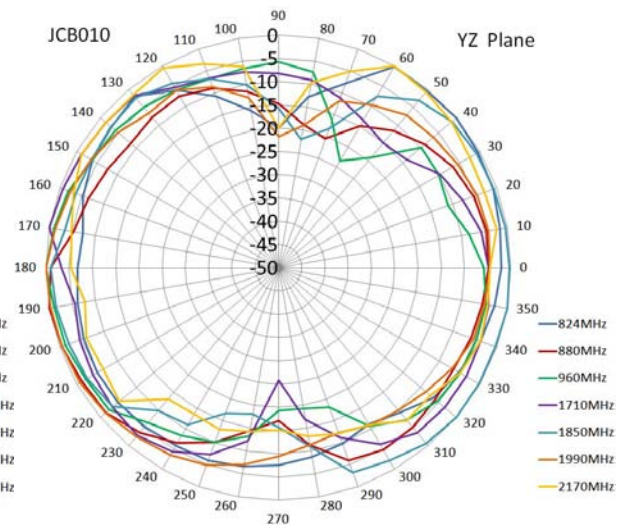
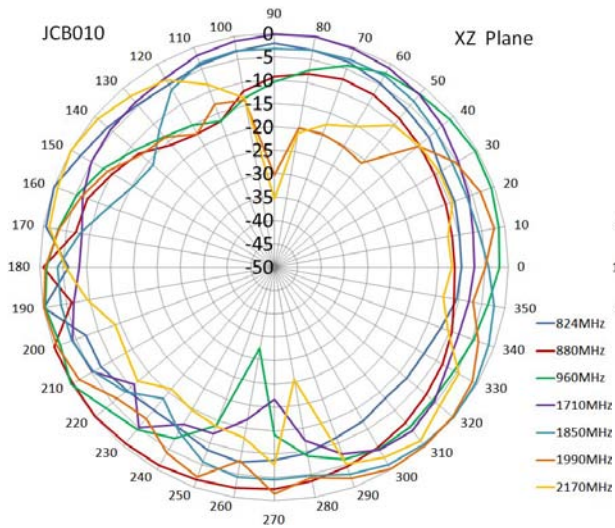
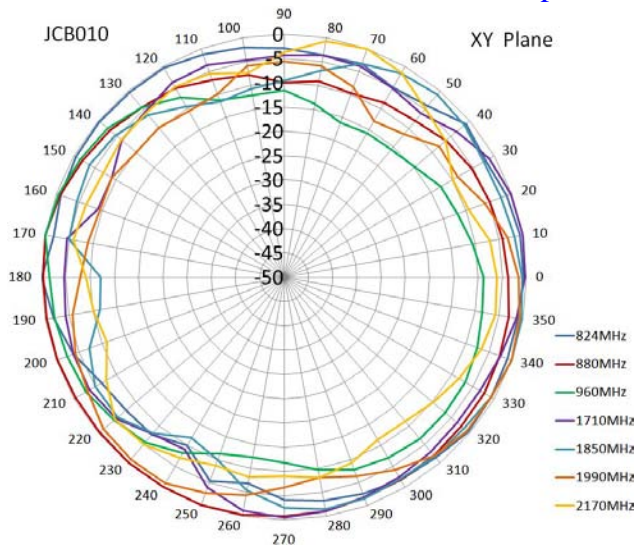

TOP ELECTRONIC INDUSTRY CO.,LTD

Rm407 27th Bldg,Nanhua Zone,Huaqiangnan,Futian Dist,SZ,GD,China

Tel:+86-755-8281 5110

Fax:+86-755-8281 5220

Web: www.topelecind.com